

QAS 150 JD iT4

Mobile Generator



Standard Scope of Supply

The Atlas Copco **QAS 150 JD iT4** generators are prime power, multi-voltage, sound attenuated, mobile generators. They are powered by a John Deere iT4 liquid-cooled, six cylinder diesel engine.

The units consist of an alternator, diesel engine, cooling system, electrical distribution and control systems - all enclosed within a sound attenuated enclosure fabricated from powder coated galvanealed steel.

A broad range of undercarriage formats and options are available.

Special attention has been given to the overall product quality, user friendliness, ease of serviceability, and economical operation to ensure best in class total cost of ownership.

Available Models

QAS 150 JD

Multiple voltage – 150kVA prime power – John Deere engine

Standard Features

- Compact, sound attenuated, corrosion resistant, with single point lifting and 110% fluid containment
- Available as a skid mounted unit with forklift pockets, or on a dual axle trailer
- Heavy Duty alternator with AREP excitation and marine grade protection
- Single side service with long run filters and 500 hour service intervals
- Extremely reliable and durable John Deere 6068
- Emergency Stop
- Remote Start / Stop

Benefits

- Extremely durable and environmentally sensitive, designed to be used for everything from the oil patch to special event power
- Versatility, giving you the flexibility to match your machine to the correct application
- Start-up power for the most demanding sites with 300% over load starting capabilities
- Heavy duty oil, air and fuel filters extend the maintenance interval to 500 hours for reduced total cost of ownership
- Reduces maintenance costs with long intervals easy access for mechanics
- Proven engine platform with high reliability
- External, recessed emergency stop for increased safety
- Allows connection as a critical back-up unit via a 2 wire dry contact connection in the distribution panel

Technical Data¹

Generator	Units	QAS 150 JD
Rated Prime Power 3Ø	kW / kVA	120/150
Rated Standby Power 3Ø	kW / kVA	132/165
3Ø Power Factor		0.8
3Ø Voltage In 480V Switch Position (Series Star w/ Neutral)	V	480Y/277
Amp Capacity @ 480V	A	180
3Ø Voltage In 240-208V Switch Position (Parallel Star w/ Neutral)	V	240Y/139 – 208Y/120
Amp Capacity @ 240V	A	361
Amp Capacity @ 208V	A	400
Rated Prime Power 1Ø	kW / kVA	83/83
1Ø Power Factor		1.0
1Ø Voltage In 120-240V Switch Position (Zig-Zag)	V	240/120
Amp Capacity @ 240V	A	400
Amp Capacity @ 120V	A	400 x 2
Alternator (4 Pole, 12 Wire)	Leroy Somer	LSA 44.2 S7
Excitation		AREP
Automatic Voltage Regulator (+/- 0.5%)	Leroy Somer	R438
Insulation		Class H
Frequency	Hz	60
Main Breaker - Shunt Trip	A	400
Power Distribution – Terminal Board		5 Wire (L1, L2, L3, N, Ground)
Terminal Board Connections		Bare Wire Terminals
Maximum Terminal Cable Size		350MCM
Convenience Receptacles ²		2 x NEMA 5-20R & 2 x 125/250V 50A CS6364

Engine	Units	QAS 150 JD
Model	John Deere	6068HFG94
US EPA Family		DJDXL06.8204
US EPA Tier		Tier 4 Interim
Displacement	L	6.8
Cylinders	#	6
Continuous Engine Power Output	HP (kW)	183 (136.5)
Gross Engine Power Output	HP (kW)	201 (150)
Rated Speed	RPM	1800
Engine Control		ECU
Aspiration		Turbocharged
Engine oil capacity ³	US Gal (L)	7.1 (27)
Engine coolant capacity	US Gal (L)	8.7 (33)
Maximum Ambient Temperature (@ Sea Level) ⁴	°F (°C)	122 (50)
Minimum Starting Temperature (Without cold weather options)	°F (°C)	14 (-10)
Minimum Starting Temperature (With cold weather kit) ⁵	°F (°C)	-13 (-25)
Electrical System (Negative Ground)	V	12
Engine Alternator Output	A	90
Battery Capacity (Cold Cranking Amps)	A	1100
Sound Pressure Level @ 23'(7 m) @ 75% Load ⁶	dB(A)	72

Fuel System	Units	QAS 150 JD
Fuel Consumption @ 25% load	US Gal/hr (L/hr)	3.0 (11.2)
Fuel Consumption @ 50% load	US Gal/hr (L/hr)	4.7 (17.8)
Fuel Consumption @ 75% load	US Gal/hr (L/hr)	6.5 (24.6)
Fuel Consumption @ 100% load	US Gal/hr (L/hr)	8.6 (32.6)
Fuel Type		Ultra Low Sulfur Diesel ONLY ⁷
Fuel Tank Capacity	US Gal (L)	219 (829)
Fuel Autonomy @ 75% load	Hr	30.3

¹ All ratings are at a reference condition of 0' altitude and 20°C (72°F)

² Please see receptacle voltage configuration in Power Distribution section on page #5

³ Engine oil to meet CJ-4 (low ash oil)

⁴ Please see "Derate Table" for altitude and temperature calculations on page #4

⁵ Cold start option comes with 120V block heater and 0W40 synthetic engine oil

⁶ Measured in accordance with ISO 2151 under free field conditions @ 7m distance

⁷ Engine and emissions require the use of Ultra Low Sulfur Diesel in accordance to ASTM-D975 Grade No.1-D S15 & No.2-D S15

⁸ Based on 90% volume of fuel tank

Dimensions

Trailer Mounted

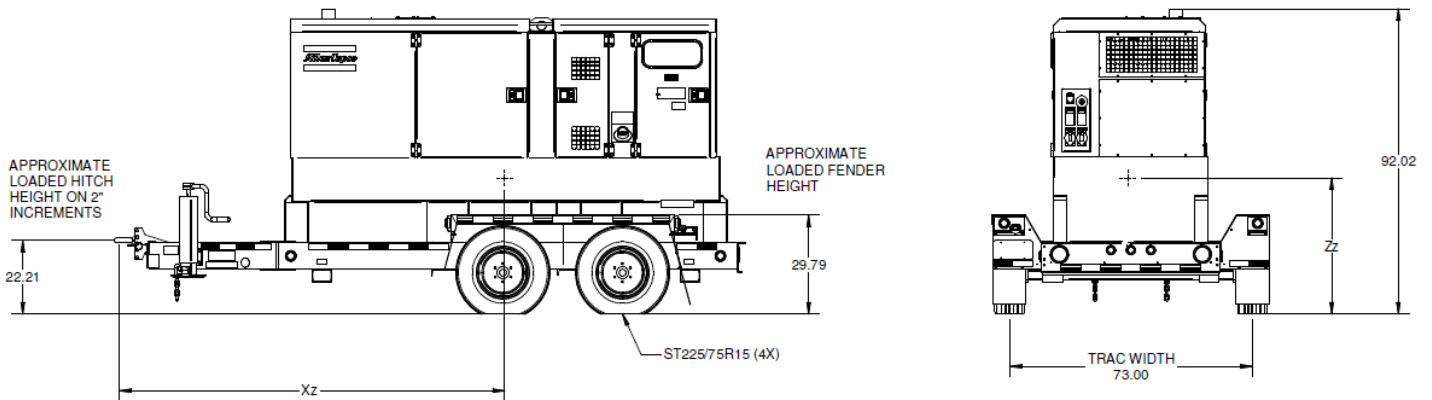

Skid Mounted

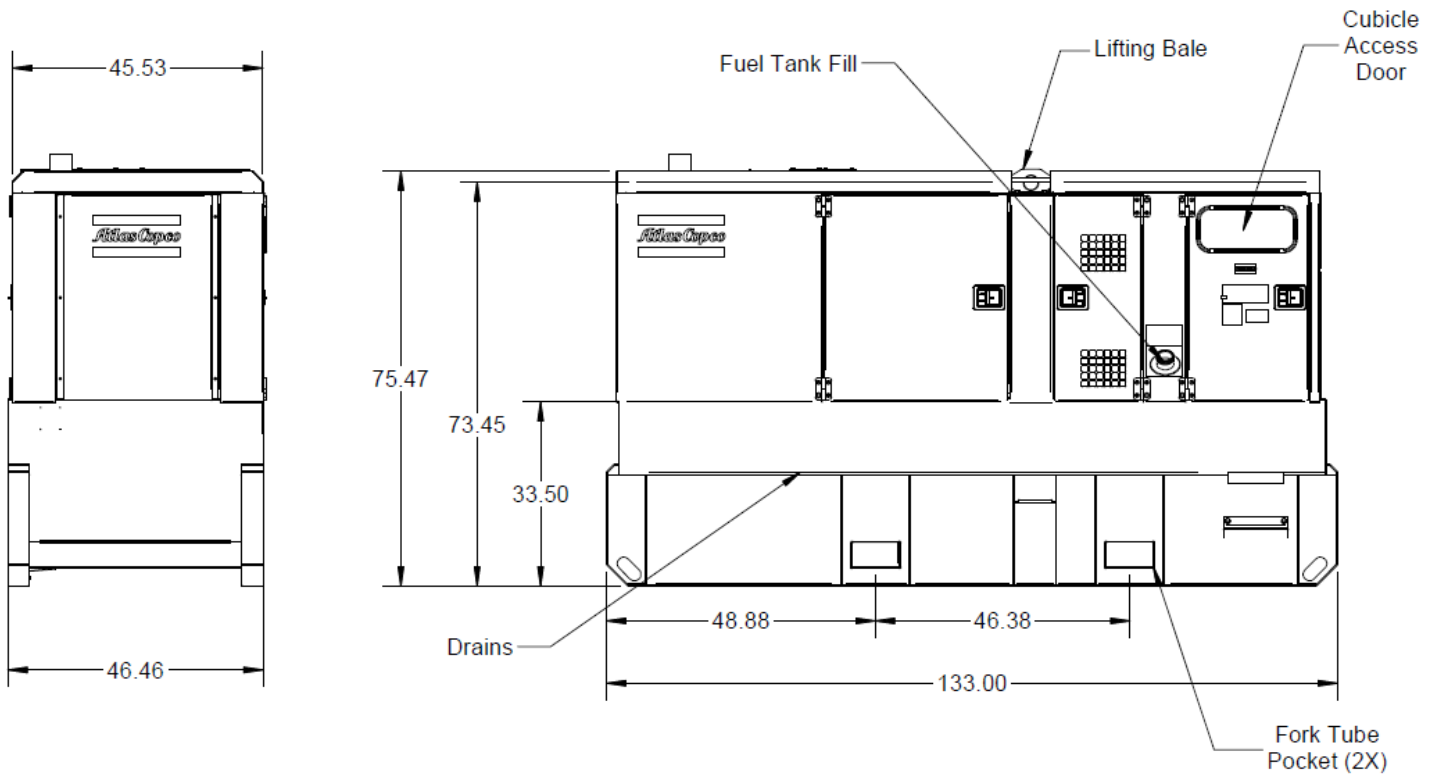

Weight - Wet (ready to operate)

Trailer Mounted
Skid Mounted

Units	QAS 150 JD
lbs (Kg)	8541 (3874)
lbs (Kg)	7484 (3395)

Dimensions

Trailer Mounted (L x W x H)
Skid Mounted (L x W x H)

Inches	191 x 94 x 92
Inches	133 x 47 x 78

Principle Data

Alternator

The Leroy Somer LSA alternators are designed for heavy duty continuous applications, with marine winding protection and Leroy Somer's AREP excitation system.

- AREP Excitation for superior motor starting capabilities
- Marine grade (relative humidity >95%) protection
- External multi-voltage selector switch (3 – position)
- 4 pole brushless design with single bearing, Class H insulation and IP23 rating
- Voltage regulation +/- 0.5%
- Full Load acceptance of prime power rating

The AREP system uses 2 independent auxiliary windings located in the main stator to send supply voltage to the AVR:

- The voltage delivered by the first auxiliary winding H1 is proportional to the alternator output voltage (shunt characteristic).
- The voltage delivered by the second auxiliary winding H3 is proportional to the current drawn by the alternator and is a function of the applied load (compound characteristic – booster effect).
- The resulting phase-to-phase voltage supplies power to the AVR.

This power supply to the AVR power circuit is independent of the voltage sensing measured on the alternator output terminals. Therefore, the excitation current delivered by the AVR to the alternator exciter is independent of any voltage distortions (harmonics) due to the load. The AREP system gives the alternator a high overload capacity (load impact or starting electric motors) and a short-circuit capability (300% - 10 s) in order to provide discriminating protection: the alternator with AREP excitation is shorter than the one with PMG excitation. It is particularly suitable for demanding applications.

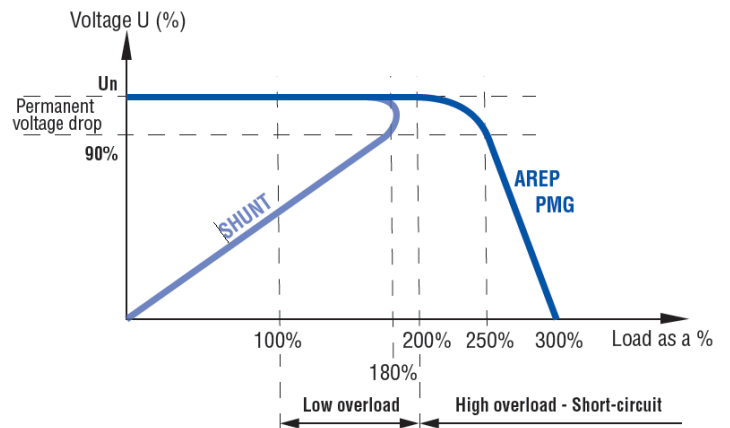
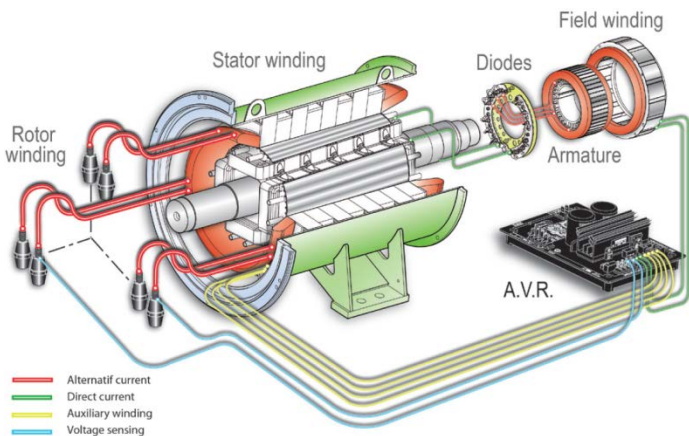

Performance @ Altitude and High Ambient Conditions

When using at altitude and high ambient conditions the engine and alternator will de-rate as per chart below.









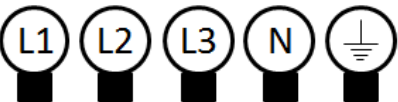

Height m (Feet)	Temperature °C (°F)										
	0 (32)	5 (41)	10 (50)	15 (59)	20 (68)	25 (77)	30 (86)	35 (95)	40 (104)	45 (113)	50 (122)
0	100%	100%	100%	100%	100%	100%	100%	100%	100%	95%	99%
500 (1640)	100%	100%	100%	100%	100%	100%	100%	100%	100%	95%	90%
1000 (3280)	100%	100%	100%	100%	100%	100%	100%	100%	100%	95%	90%
1500 (4921)	100%	100%	100%	100%	100%	100%	100%	100%	95%	95%	85%
2000 (6561)	95%	95%	95%	95%	95%	95%	95%	95%	95%	90%	85%
2500 (8202)	90%	90%	90%	90%	90%	90%	90%	90%	90%	85%	80%
3000 (9842)	90%	90%	90%	90%	90%	90%	90%	90%	90%	85%	80%
3500 (11,482)	85%	85%	85%	85%	85%	85%	85%	85%	85%	75%	75%
4000 (13,123)	85%	85%	85%	85%	85%	85%	85%	85%	85%	75%	75%

Power Distribution

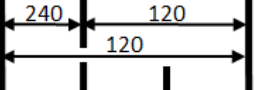
The main power is connected from the alternator through a 3 position voltage selector switch to the main power cubicle. The cubicle incorporates all power distribution, controls, sensing and protection devices.

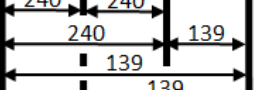
- ✓ 3 position Voltage Selector Switch (VSS)
- ✓ Current transformer x 3 (1 each leg)
- ✓ Single main breaker w/shunt trip
- ✓ Individual breakers for each receptacle
- ✓ Convenience receptacles located on outside of unit for easy access
- ✓ Terminal board for hard wiring
- ✓ Cam-Lock external quick connect (available as option)
- ✓ External emergency stop switch (recessed)
- ✓ Neutral bonded to Ground with a removable bonding link accessible in the control cubicle

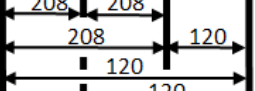
Please refer to the chart below for power distribution and voltages. NOTE: All voltages below are subject to change, depending on set point of "Fine Voltage Adjustment" potentiometer and Voltage Selector Switch.

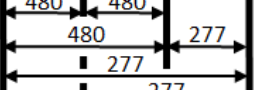
		120V Receptacle NEMA 20-5R	125/250V Receptacle CS6364	Terminal Board
Fine Voltage Adjustment ↓	Voltage Selector Switch Position ↓			
	 240/120V 1Ø	120V	240/120V	
	 240/208V 3Ø	139V	240/139V	
	 240/208V 3Ø	120V	208/120V	
	 480V 3Ø	139V	240/139V	

- All voltages are adjustable with the "Fine Voltage Adjustment" potentiometer located on the control panel. Therefore voltage may be different then what is shown in the above table. All voltages should be verified before connection to the unit.

Controller

The QAS 150 comes equipped with an Atlas Copco Qc1002 control module. This is a fully diagnostic ECU controller with large 3" display, that is intuitive and easy to operate with all functions conveniently at your fingertips. The controller also manages the engine ECU operating system, and a number of safety warnings and shut downs on various parameters (listed below).

The controller is powered by a main On/Off switch located next to unit.

Atlas Copco Qc1002 Controller Functionality:

- Home Pages
 - ✓ Shows one line voltage and frequency of generator
 - ✓ Shows fuel level
 - ✓ Shows oil pressure
 - ✓ Shows coolant temperature
 - ✓ Shows battery voltage
 - ✓ Shows service timer
 - ✓ Shows RPM
 - ✓ Shows DPF Level
- Alarm List
 - Gives view of active alarms
- Remote Start/Stop
 - ✓ Automatic start stop via 2 wire dry contact connection
- Log List
 - ✓ Event memory of last 20 alerts
- Parameters
 - ✓ Enables connection to service port on engine
 - ✓ Unit Type configuration
 - ✓ Service timer reset (2 service timers)
 - ✓ Unit of measure
 - ✓ Language
 - ✓ Stationary Regeneration (DPF)
 - ✓ Over and under frequency alarm
 - ✓ Over and under voltage alarm
- Engine DM1 Page
 - ✓ This page contains any active Diagnostic Trouble Codes that the engine ECU is currently generating. These alarms are conditions detected by the engine ECU and displayed on the DSE controller.



Engine

John Deere

John Deere Interim Tier 4 Final, turbo charged, six-cylinder, liquid-cooled diesel engine provides ample power to operate the generator continuously at full-load.

Meets all US EPA, CARB and Environment Canada exhaust legislations with Interim Tier 4 compliance. The engine utilizes a Diesel Oxidation Catalyst (DOC) to meet Interim Tier 4 emissions. All functionality of the engine is controlled automatically on the Atlas Copco Qc1002 controller.

The engine has the capability to start the generator at 14°F (-10°C) with standard glow-plug aid. Cold start options are available for machine starting for down to -13°F (-25°C).

The 219 Gal (829L) fuel tank is sufficiently sized to operate the unit at full-load condition for long run times (see chart on page 2 for specifications).

The engine operates on a 12V negative ground electrical system with a 90A charging alternator.

The cooling system is suitably designed for continuous operation in ambient conditions up to 122°F (50°C), with canopy door closed.

Fuel System

A large 219 US Gal (829L) steel fuel tank provides safe diesel storage while eliminating tank corrosion contaminants from being introduced to your fuel system. With integrated fuel water separator and filter, the system is designed to help maintain clean and trouble free diesel supply to the engine for reliable trouble free operation.

- ✓ Lockable diesel fill cap
- ✓ Fuel / Water separator
- ✓ Inline priming pump (w/ filter)
- ✓ Fuel pre-filter
- ✓ Fuel supply pump (w/ strainer)
- ✓ Fuel level sensor
- ✓ Low fuel shut down feature (programmable level)

Scheduled maintenance

Standard equipped with filters sized and designed to allow 500 hour service intervals under normal operating conditions. Extended time between services reduces down time and total cost of ownership of the unit over its lifetime.

- 500 Hour Service Interval:
 - ✓ Air filter
 - ✓ Oil filter
 - ✓ Fuel filter
 - ✓ Fuel / water separator

NOTE: Site specific operating conditions such as; poor fuel quality and low load profile may require more frequent service intervals.

Enclosure & Frame

The generator enclosure is designed for extreme applications to provide superior performance and reliability.

The enclosure is fabricated from galvaneal coated steel which is powder coated for corrosion resistance. The enclosure and frame are fully sealed from the radiator to the back of the unit, providing a true 110% containment of all fluids.

- ✓ Galvanealed, powder coated enclosure
- ✓ Heavy duty base frame
- ✓ 110% fluid containment
- ✓ Larger 219 gallon, steel fuel tank
- ✓ Superior level of rain ingress protection and design features
- ✓ Pad-lockable doors and fuel cap
- ✓ Engine fluid plumbed to exterior of frame for ease of service
- ✓ Central lifting point
- ✓ Sound dampening material and design to allow quiet operation at 71 dB(A)

Undercarriage

The QAS 150 is available with two undercarriage alternatives, providing utmost flexibility in installation, site handling or towing. Both the skid frame and the trailer mount the same way and can be interchanged for versatility.

- Trailer mounted:
 - ✓ Dual axle trailer
 - ✓ Available with hydraulic or electric brakes
 - ✓ DOT/Federal MVSS 49CFR571 approved light package
 - ✓ Adjustable height pintle hitch (3" lunette)
 - ✓ 15" Rims w/ ST225/75R15D Tires for trailer use
 - ✓ Heavy Duty torsion axle
 - ✓ Safety chains
 - ✓ Screw jack leveling, with pad foot, 3,000 lbs static capacity
 - ✓ Single point lifting structure
 - ✓ D-Ring Tie down points x4

- Skid mounted:
 - ✓ Sub-frame skid with integrated forklift pockets
 - ✓ Heavy duty design for use in extreme conditions
 - ✓ Frame is ¼" wider than machine to reduce damage from forklifts
 - ✓ Built-in locations for straps or chains to secure the unit for transport
 - ✓ Single point lifting structure



Factory Options Available

- Dual axle trailer with hydraulic or electric brake package
- Heavy duty skid with forklift pockets
- Trailer stabilizer jacks
- Trailer mounted tool box
- Trailer spare tire
- Battery charger (12V)
- Battery isolation switch (lockable)
- Cam-Lok quick connections (5 x 400A)
- External fuel quick connects (3 way valve, located inside of enclosure for spill containment and protection)
- CSA approval
- MVT (Multi-Voltage Technology) 600V option

Manufacturing & Environmental Standards

The **QAS 150 JD iT4** is manufactured following stringent ISO 9001 regulations, and by a fully implemented Environmental Management System fulfilling ISO 14001 requirements.

Attention has been given to ensure minimum negative impact to the environment.

The **QAS 150 JD iT4** meets all current US EPA, CARB and Environment Canada exhaust and noise emission directives.



Supplied Documentation

The unit is delivered with documentation regarding:

- Hard copies of the Atlas Copco Operators Safety and Instruction Manual, Atlas Copco Parts Book, John Deere Engine Manual and Parts book, in English as well as electronic copies available on request.
- Warranty Registration card for engine and Atlas Copco Generators (Units must be registered upon receipt).

Warranty Coverage

Atlas Copco Generator: Warranted to be free from defects with regard to material and workmanship for the period of eighteen (18) months from date of shipment from the factory, or twelve (12) months from date of initial startup, whichever occurs first, without limitation of running hours.

John Deere Engine: Warranty from John Deere. Unit must be registered directly with John Deere upon receipt to be eligible for warranty. Failure to register warranty upon initial startup may cause warranty claim delays or rejection of claim by John Deere.

John Deere Diesel Engines are warranted to be free from defects with regard to materials and workmanship for the period of twelve (12) months from the date of initial startup, without limitation in running hours, or the period of the twenty-four (24) months from the date of initial startup, prior to the accumulation of 2,000 running hours. Emission control components are warranted for 5 years or 3,000 hours.

Leroy Somer Alternator: Warranted to be free from defects with regard to material and workmanship for the period of twenty seven (27) months from date of shipment from the factory, or twenty four (24) months from date of initial startup or 10,000 hours, whichever occurs first.

Extended Warranty Programs: Programs are available; please contact your local sales representative for more info.